

DDBioSplint^{PHI}

high impact thermoplastic

Your benefits:

- biocompatible – medical thermoplastic, no chemoplastic!
- industrially polymerised – minimal residual monomer content
- high fracture resistance and long-term stability (bruxism treatment)
- lowest water absorption – long-term stability of the fit
- good polishing properties – smooth surfaces are less susceptible to discoloration and plaque deposits, which at the same time minimises the risk of inflammation.

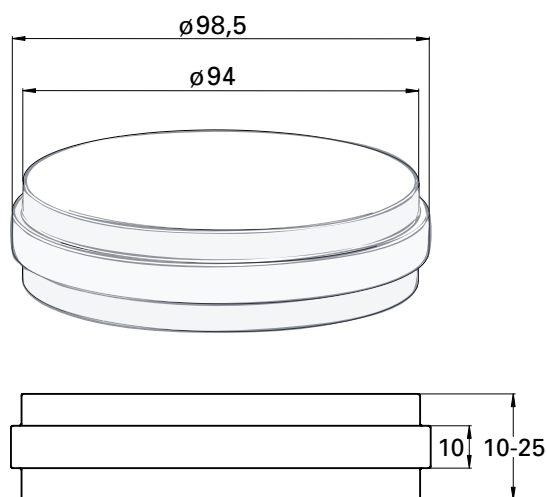

| Technical data | |
|---|---|
| Material | 100% PMMA |
| Indication | Bite guard splint, therapeutic splints, bite regulators (Due to its properties, the material is indicated for the oral cavity up to 12 month.) |
| Color | clear |
| Flex resistance ISO 178 | 92 MPa |
| Charpy impact strength +23°C ISO 179/1eU | 45 kJ/m ² |
| Density ISO 1183 | 1,17 g/cm ³ |
| Water absorption ISO 20795-1 | 0,02 µg/mm ³ |
| Solubility ISO 20795-1 | 0,0 µg/mm ³ |
| residual monomer content ISO 20795-1 | < 0,7 % |
| CAM system | open systems for Ø 98,5 mm blanks, e.g.: LabTec (Dental Direkt), CORiTEC® (imes-icore), Zeno® TEC (Wieland Dental), Impression (VHF), DWX 50 (Roland), etc. |

See consult instructions for use.
*ISO 6872:2015

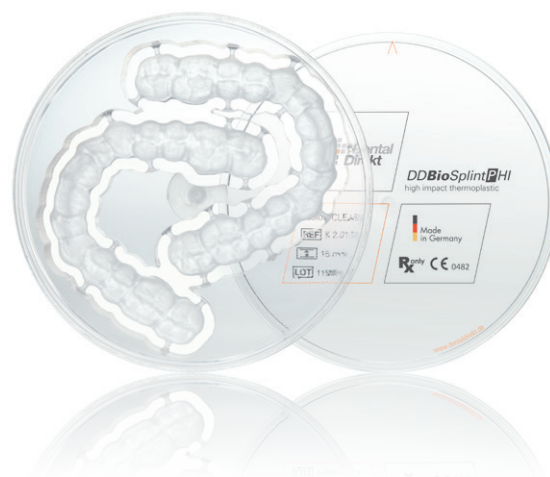

DDBioSplint^{PHI98}

| measures | art. no. | item | price/item (Euro/net) |
|--------------|----------|------|--------------------------|
| 98.5 x 15 mm | K40115 | 1 | 29.00 |
| 98.5 x 20 mm | K40120 | 1 | 35.00 |

Names marked with ® are registered trademarks of the manufacturers. For incorrect information in this price list and its consequences we assume no liability. Our general terms and conditions apply. All prices are net prices excl. VAT. We reserve the right to make technical changes, price changes and delivery options.

High-performance polymer For digital splint therapies

DDBioSplint^{PHI} high impact thermoplastic

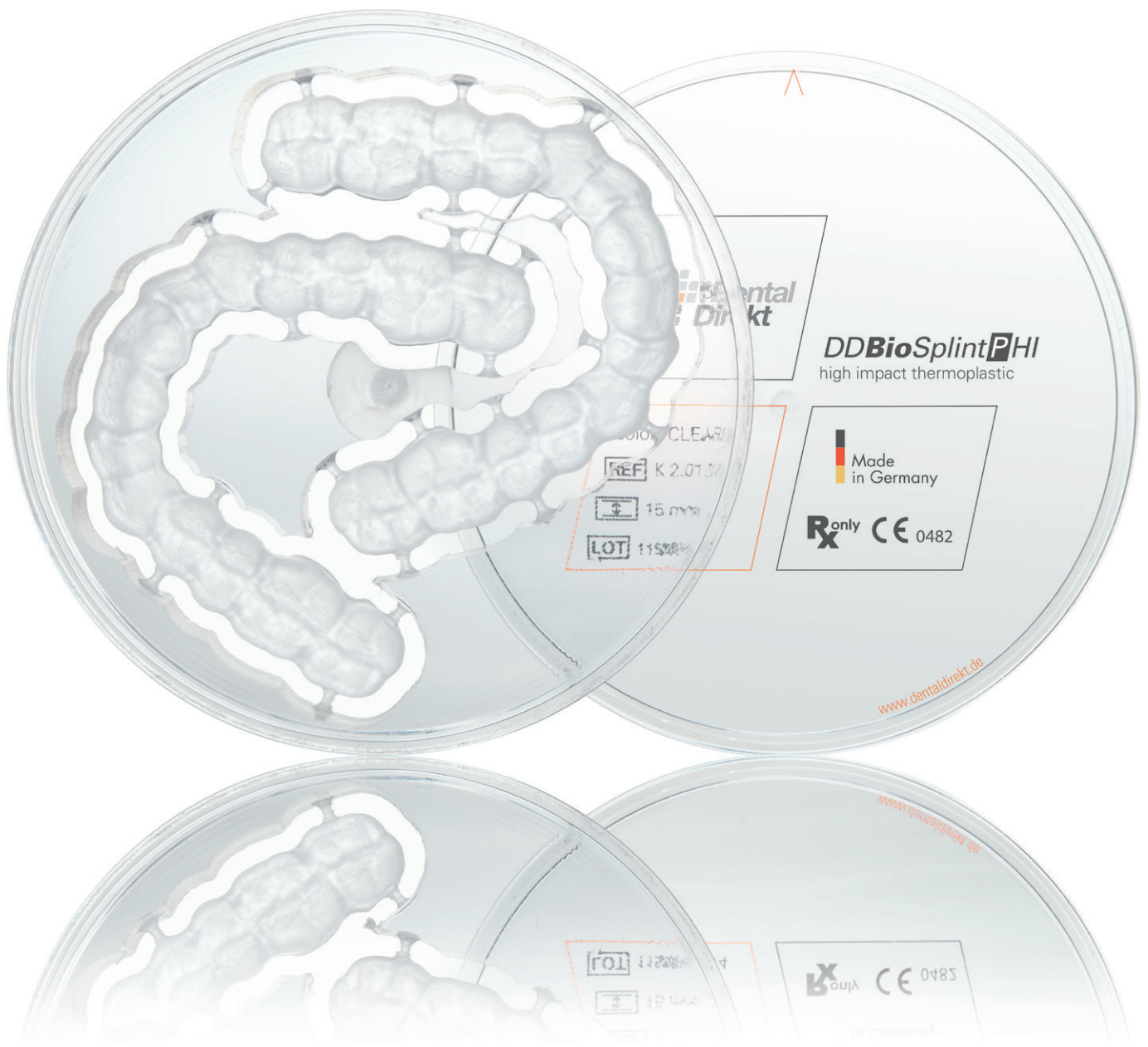

DD Bio Splint P HI

high impact thermoplastic



High impact strength – high reliability

The aim of our developers was to create an ideal material for CAD/CAM-milled functional splints. The visco-plastic DD Bio Splint P HI is extremely resistant due to a molecular modification. Its mechanical properties are specifically optimised to the demands of functional splints.

E modulus

The elastic modulus demonstrates the resistance of a material against the elastic deformation and is therefore a measure of its rigidity. An E modulus of at least 2000 MPa must be guaranteed in accordance with EN ISO 20795-1, to ensure that prostheses and splints do not inappropriately deform under the stress of chewing.

The DD Bio Splint P HI has a low E modulus compared with standard PMMA and therefore a higher elasticity. As an elastic material can deform to a greater extent under stress, the chewing forces are better absorbed. The intelligent, impact-absorbing effect reduces the forces exerted on the tooth and periodontic apparatus by unphysiological stresses, such as parafunctions.

Impact-absorbing effect

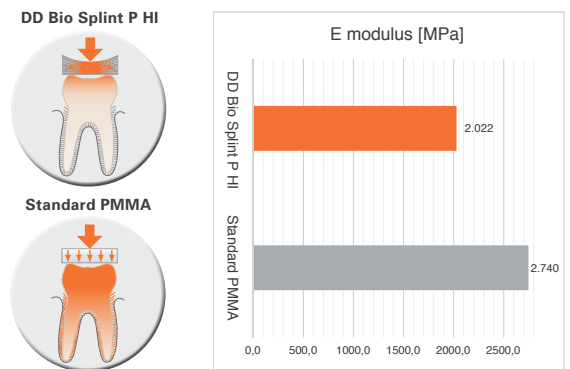

Fracture resistance / impact strength

The fracture toughness describes the resistance of a material to the propagation of microfissures, which can lead to failure of the construction. This is significantly important for the long-term stability. It is measured as total tensile energy absorption [J/m²] in high impact polymers. The impact strength in contrast describes the ability of a material to absorb shock and impact energy without breaking.

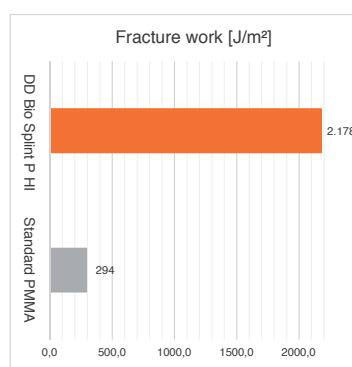

The total tensile energy absorption should be at least 900 J/m² for materials with increased impact strength according to ISO 20795-1.

Increased durability

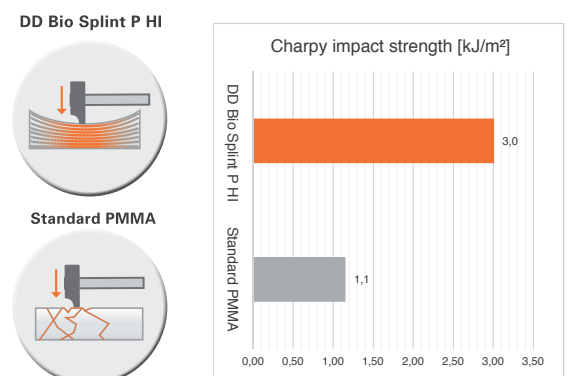

Our DD Bio Splint P HI is adjusted for an extremely high impact strength. In this way, we achieve a PMMA with exceptional fracture resistance properties. The material is robust, does tolerate small faults and is designed for high, permanent intra-oral stress. Furthermore, the therapy splints do not break as easily as those made of standard PMMA when handled by the patients. The impact pressure is better absorbed, for example, when the piece is dropped.

Residual monomer content

When producing a chemical product such as a medical polymer, for us only a thermoplastic manufacturing process was worth considering. In this way, we can guarantee the best biochemical properties and biocompatibility. Residual monomers and other allergenic components found in many chemoplastics are reduced to an absolute minimum. Under certain circumstances, residual monomers (MMA) can lead to sensitisation of the oral mucosa. The industrial polymerisation of our raw materials guarantees the best possible conversion of the monomers. The material is developed for splint therapies, but also fulfils all the requirements set out in standards for permanent, biocompatible prostheses.

Water absorption

Plastics take up liquids, which can lead to surface swelling and in turn to changes in the volume and difficulties with the fit, which themselves can have negative effects on the mechanical properties of the materials.

Water absorption by DD Bio splint HI is considerably below the maximum value stipulated by ISO 20795-1 and is therefore classified as extremely low. Therefore, long-term fit and prosthetic stability is guaranteed.

Lowest possible water absorption

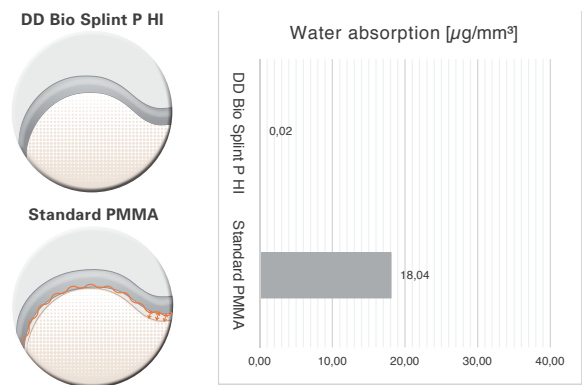

Our transparent production

The high innovation and quality standards of today's international plastics industry are compelling. We are developing these for the dental area and in doing so are expanding the possible functional and aesthetic applications. The term high-performance polymers is applied to a range of plastics in dentistry, without a clear definition. This new generation of high-impact PMMA are well worthy of the name. The combination of biocompatible, polymerised raw granulates in combination with an elaborate injection-moulding process under extreme pressure conditions, gives our polymer blanks excellent long-term stress characteristics. See for yourself in our transparent production.

