

DDSolidConnect[®]

Produktkatalog
Implantat-
komponenten



CLOSE TO YOU

Verbunden fürs Leben

Implantatkomponenten vom Komplettanbieter.

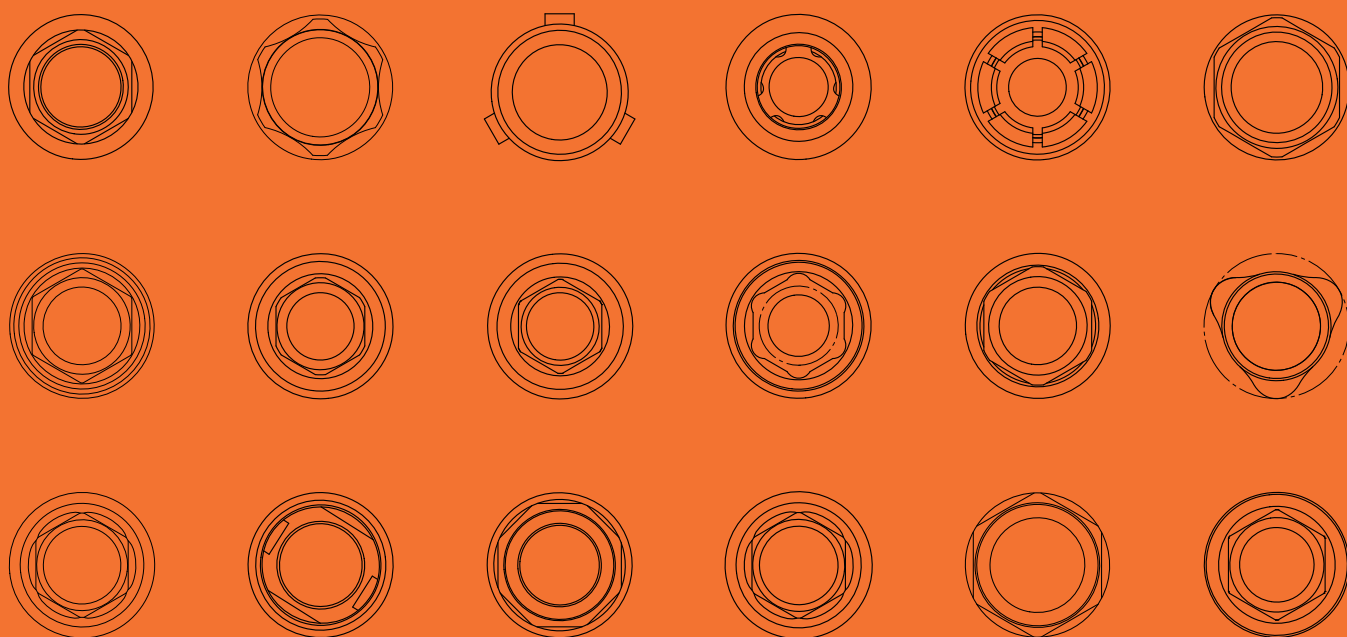

DDSolidConnect[®]

Qualität und Sicherheit – Made in Germany.
Eine Partnerschaft fürs Leben.



DD Solid Connect®

DD Solid Protect Garantie	04
Produktportfolio DD Solid Connect®	06
DD Prefab und DD Prefab-Halter	08
DD Scanbody 2.0	10
DD Ti-Base 2CUT DD Ti-Base 2CUT noLock	11
Implantatkomponentenverpackung	12
DD Fusion Analog	13
Workflow-Kompatibilität	14
Implantatkomponenten Kompass	16

Serien

	Herstellerkompatibilität Systemübersicht	18
AAS-Serie	DENTSPLY Implants® Astra Tech TX	20
BSK-Serie	Bredent Medical Sky®	21
CCA-Serie	Altatec Camlog®	22
CCO-Serie	Altatec Conelog®	23
DEV-Serie	DENTSPLY Implants® Astra EV	24
DFX-Serie	DENTSPLY Implants® Frialit® / Xive®	25
MAR-Serie	MegaGen AnyRidge®	26
MMI-Serie	Medentis Medical® ICX	27
MSE-Serie	MIS Implants® Seven®	28
NBR-Serie	Nobel Biocare™ Brånemark™	29
NNA-Serie	Nobel Biocare™ Nobel Active®	30
NRE-Serie	Nobel Biocare™ Replace Select®	31
OTS-Serie	Osstem Implant TS	32
SBO-Serie	Straumann® Bone Level®	33
SSY-Serie	Straumann® Tissue Level	34
TSP-Serie	Thommen Medical SPI®	35
ZBC-Serie	Zimmer Biomet 3i Certain®	36
ZTA-Serie	Zimmer Dental Tapered Screw-Vent®	37

Starter Kits und Zubehör

38



Hier finden Sie den
Katalog zum Download



 Made
in Germany



Ersatzlieferung

Sie erhalten einen kostenlosen Ersatz der DD Solid Connect®-Abutments und -Schrauben.



Kostenerstattung Suprakonstruktion

Ihnen werden alle notwendigen Kosten wie z.B. Kronen- und Brückenkonstruktionen erstattet – dabei sind auch Fremdlaborleistungen inkludiert.



Fremdimplantat-Garantie

Sollte der Implantathersteller seiner Garantieleistung aufgrund der Kombination des Implantats mit einem DD Solid Connect® Produkt nicht nachkommen, erstattet Dental Direkt die Kosten des Fremdimplantats. Sie erhalten von uns so lange eine Garantieleistung, wie sie auch vom Implantathersteller gegeben wird.



Behandlungskostenübernahme 1.500 € pro Implantat

Im Falle eines Implantatverlustes übernimmt Dental Direkt die Behandlungskosten für den Chirurg/Zahnarzt.

Reguliert wird nach aktuellen Protokollen, Richtlinien und Anleitungen des Implantatherstellers und den gültigen Stellungnahmen der Deutschen Gesellschaft für Zahn-, Mund- und Kieferheilkunde und der Fachgesellschaften.



DGZMK
dgzmk.de

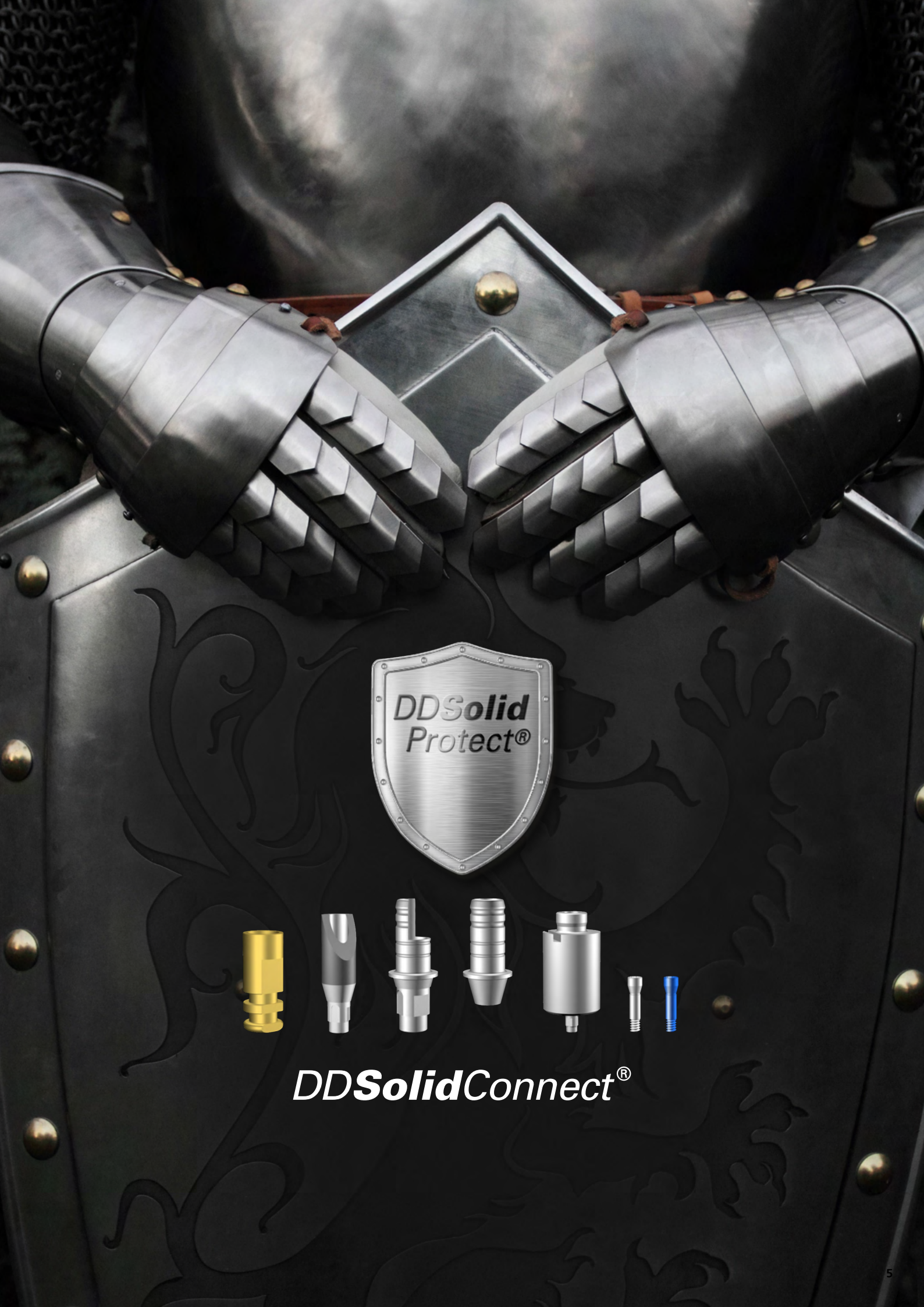

DDSolidConnect®



Willkommen im Produktportfolio von DD Solid Connect® – den Komponenten für eine moderne und zukunftsweisende Implantatversorgung.

Modern und zukunftsweisend, weil wir als Komplettanbieter im Dentalmarkt und Hersteller von dentalen CAD-CAM Materialien unser ganzes Wissen in die Wagschale werfen. Unsere Forschungs- und Entwicklungsarbeit ist dynamisch eng mit unserer Materialherstellung und Produktion verzahnt.

Das Ergebnis: Implantatkomponenten mit einer lebenslangen DD Solid Protect® Garantie auf die Funktion der Versorgung.

Alles aus einer Hand – Qualität und Sicherheit sind **Made in Germany** – zu einem fairen Preis. Eine Partnerschaft fürs Leben.



Perfekte Prothetik ist mehr als die Summe ihrer Teile. Komponenten und Materialien sind in ihrer Funktion und Ästhetik perfekt aufeinander abgestimmt.



Fräsrohling



Titanklebebasis

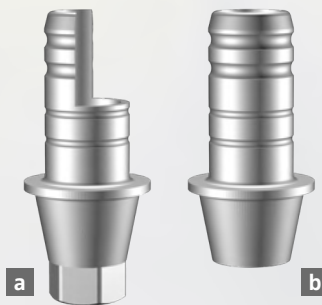

Scanbody



DD Solid Connect® Produktbezeichnung

DD Prefab

- a DD Ti-Base 2CUT
- b DD Ti-Base 2CUT noLock

DD Scanbody 2.0

Modellanalog



Schrauben

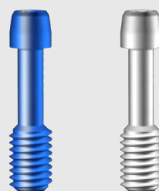

DD Solid Connect® Produktbezeichnung

DD Fusion Analog

- DD Lab Screw (blau anodisiert)
- DD Implant Screw (silber)



Vorteile

- **Rotationsschutz** zur Ausrichtungshilfe und zur Verringerung der Vibrationen
- Abutmentschraube **identisch zur originalen Implantatschraube**

Extra

- 100%ige Designfreiheit durch **0,0 mm Gingivahöhe**



Verwendung

- Verfügbarkeit für **18 der gängigsten Implantatsysteme**
- Einfache Verwendung Dental Direkt programmierter CAD und CAM Bibliotheken (**digitale Bibliotheken auch für Scanbodies von NT-Trading und Medentika® verfügbar**)

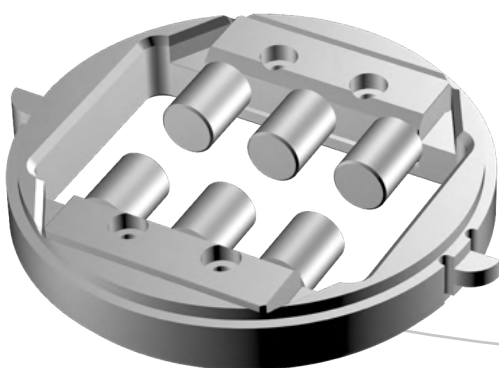

DD Prefab-Halter SilaMill

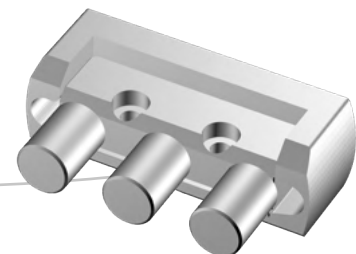

DD Prefab-Halter SilaMill

CAM-Software: DD smart CAM 2.0 by workNC Dental, SUM3D, imes-icore V5, DS CAM V4/V5, Hyperdent, Dentalcam 8 (vhf)



Vorteile

- **Rotationsschutz** gleichzeitig **Vibrationsbrecher**
- Bearbeitung von sechs Prefabs gleichzeitig möglich

Verwendung

- Exocad, 3Shape CAD-Software

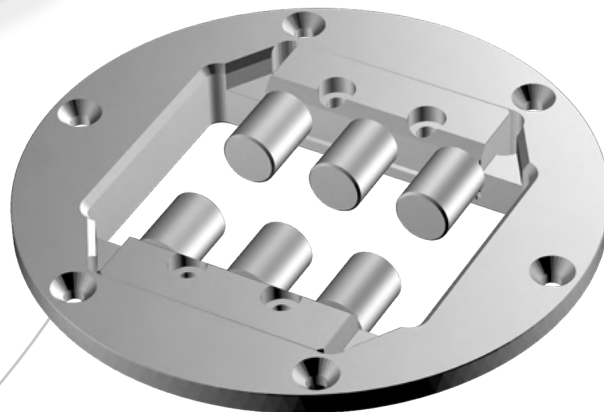

DD Prefab-Halter imes-icore

CAM-Software: DD smart CAM 2.0 by workNC Dental,
SUM3D MillBox/Expert, imes-icore V5, DS CAM V4/V5,
Hyperdent, zfx Inhouse5x

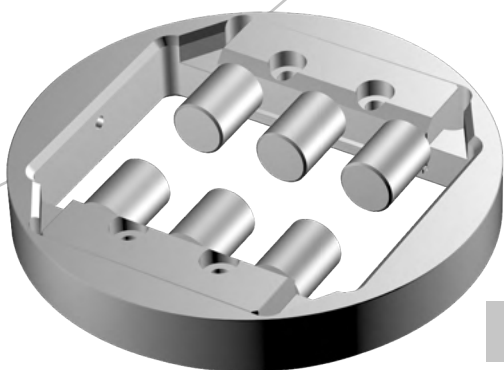

DD Prefab-Halter MB



Vorteile

- Mehr Genauigkeit durch **Einteiligkeit**
- **Sterilisierbares Titaninterface**

Extra

- Optimales Scanverhalten durch **Oberflächenkonditionierung des Titans**

Verwendung

- Intraoral und extraoral anwendbar
- Bibliotheken auch für Scanbodies von NT-Trading und Medentika® verfügbar
- Bei intraoraler Verwendung kann der Zahnarzt seine original Werkzeuge benutzen
- Einsatz bei komplizierten Implantatpositionen durch schräge Form
- Geringer Platzbedarf durch schlankes Design

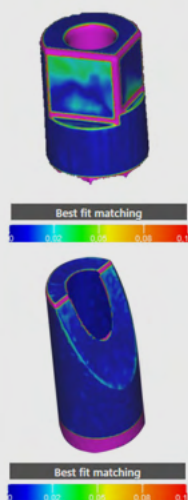
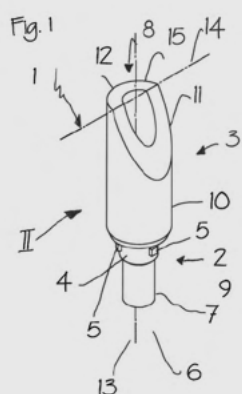

Der komplett aus Titan (Grade 5 ELI) gefertigte Scanbody erhöht die Präzision des Scanergebnisses und vermindert die Gefahr von Fehlern in der Zentrik.

Verhinderung von Scanartefakten durch eine spezielle Oberflächenbehandlung, die Spiegelungen verhindert.



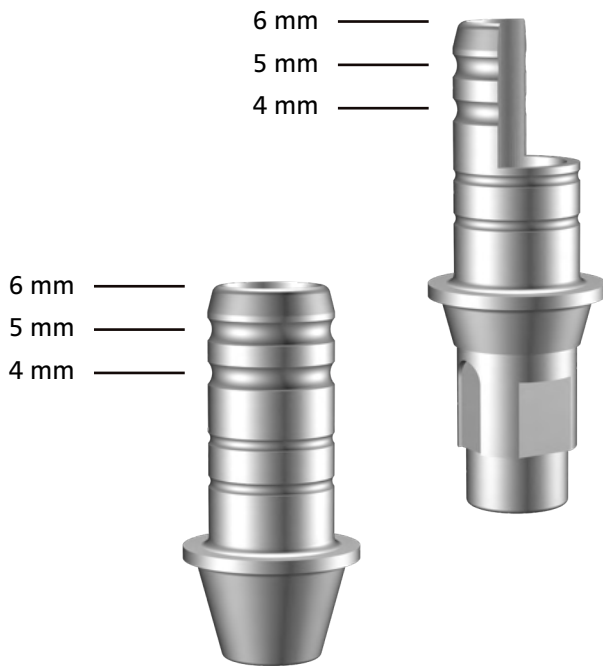

Durch die individuell kürzbare Kaminhöhe kann die Länge der Klebebasis an die Anforderungen des Einzelfalls angepasst werden.



Der Verdreherschutz auf dem Kamin ermöglicht eine einheitliche, zirkuläre Materialstärke der Zirkonrestauration und bietet so eine ideale und schonende Unterstützung für die Keramik.

Die DD Solid Connect® »2CUT« Klebebasen sind rotationsindexiert oder als Variante »noLock« frei rotierend für Brückenversorgungen verwendbar.

Vorteile

- **One Fit All** – Höhe individuell kürzbar
- Höchste Haltbarkeit dank optimierter Klebefläche

Extra

- Dank einer minimalen Gingivahöhe von 0,3 mm ist eine individuelle Designfreiheit gegeben.
- Da die noLock-Variante Rotationsfreiheit bietet, eignet Sie sich perfekt für mehrgliedrige Versorgungen.

Verwendung

- Bibliotheken auch für Scanbodies von NT-Trading und Medentika® verfügbar
- Bei intraoraler Verwendung kann der Zahnarzt seine original Werkzeuge benutzen
- **Ti-Base 2CUT:** Zur Befestigung von individualisierten Kronen- und Abutmentversorgungen.
- **Ti-Base 2CUT noLock:** Zur Befestigung von individualisierten Brücken- und Stegversorgungen.

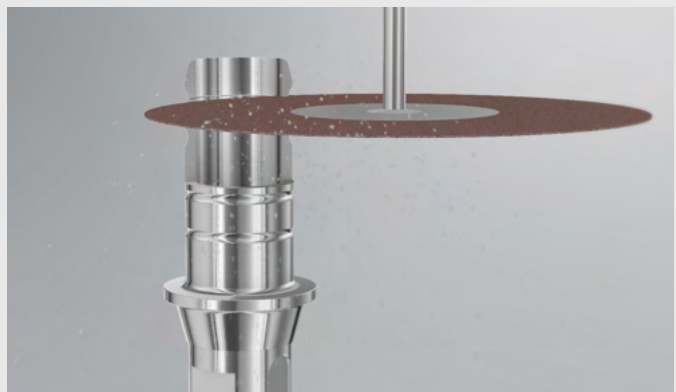



Vorteile

- Aufkleber für Chargenrückverfolgung
- Schrauben einzeln verpackt
- Praktische Perforation zum Abtrennen
- Klare Orientierung durch farbliche Unterscheidung:
 - Laborschraube (blau)**
 - Fertigung aus Titan Grade 5 ELI
 - Torx® Schraubenkopf T6 bei allen Systemen
 - Implantatschraube (silber)**
 - Fertigung aus Titan Grade 5 ELI
 - Komplette Schraube identisch zum Originalhersteller

Komponenten mit zwei Schrauben

- Prefab
- Ti-Base 2CUT
- Ti-Base 2CUT noLock
- Scanbody 2.0

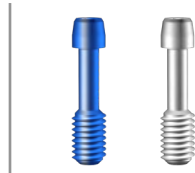

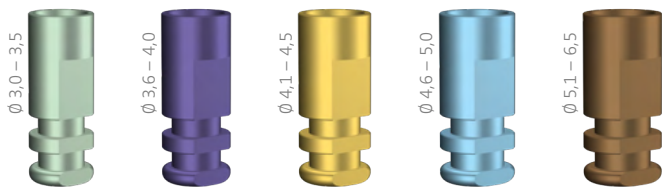
Titan
Grade
5 ELI

Vorteile

- Präzise Positionierung im 3D Modell durch haptisches Feedback («klick»)
- Erhöhte Prozesssicherheit im Modell-Builder durch Kennzeichnung des ausgewählten Implantates auf dem Fusion Analog

Extra

- Eigens designte Einbringhilfen einzeln oder als Set
- Einfache Zuordnung durch durchmesserspezifischen Farbcode





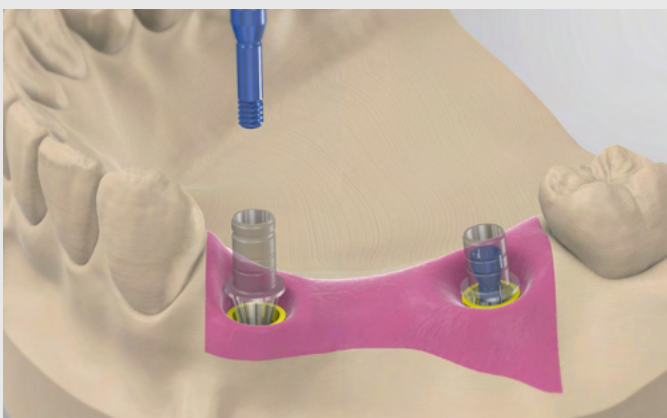
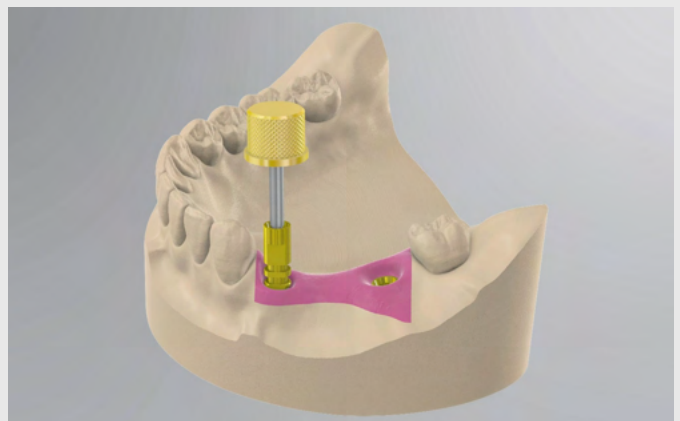

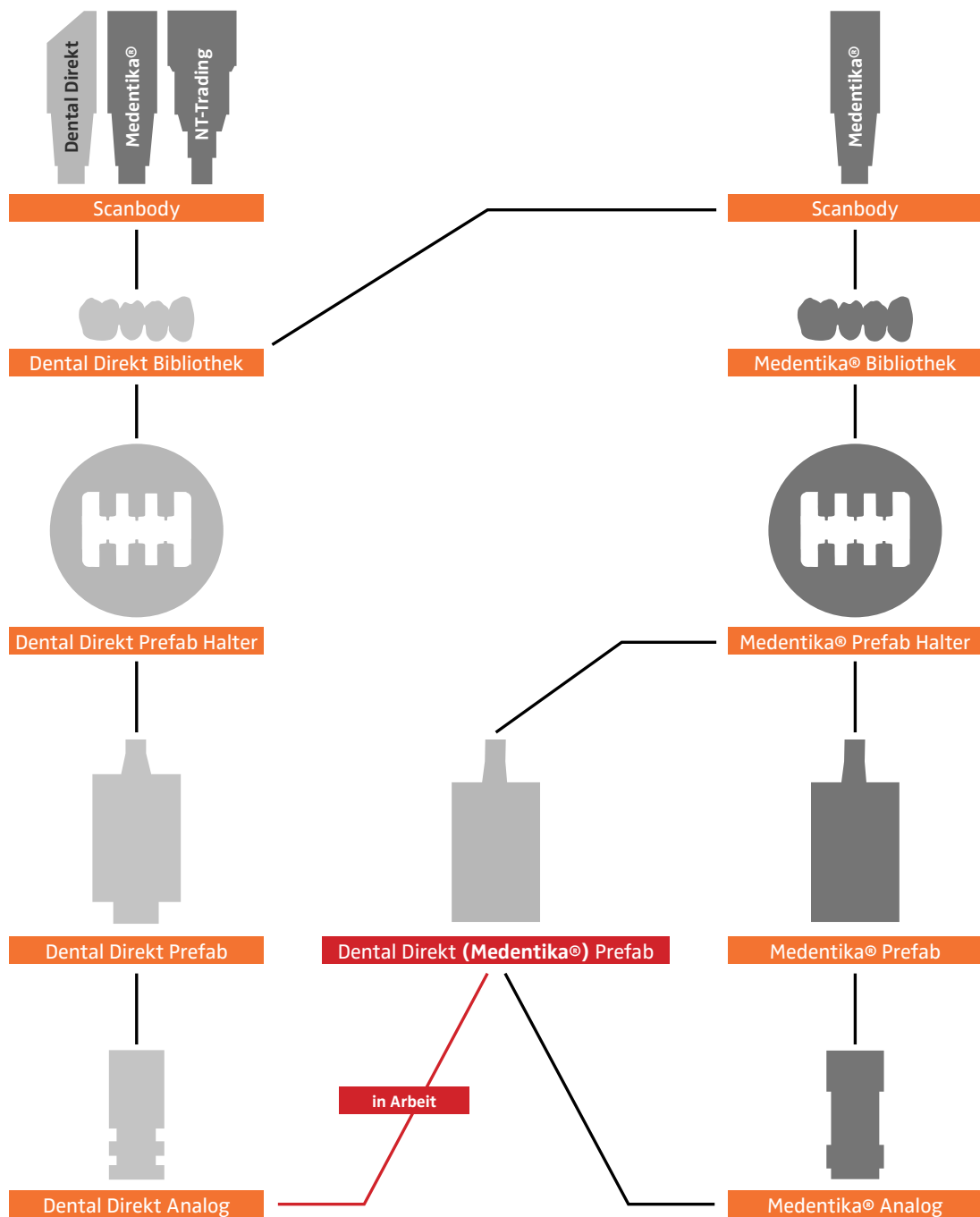

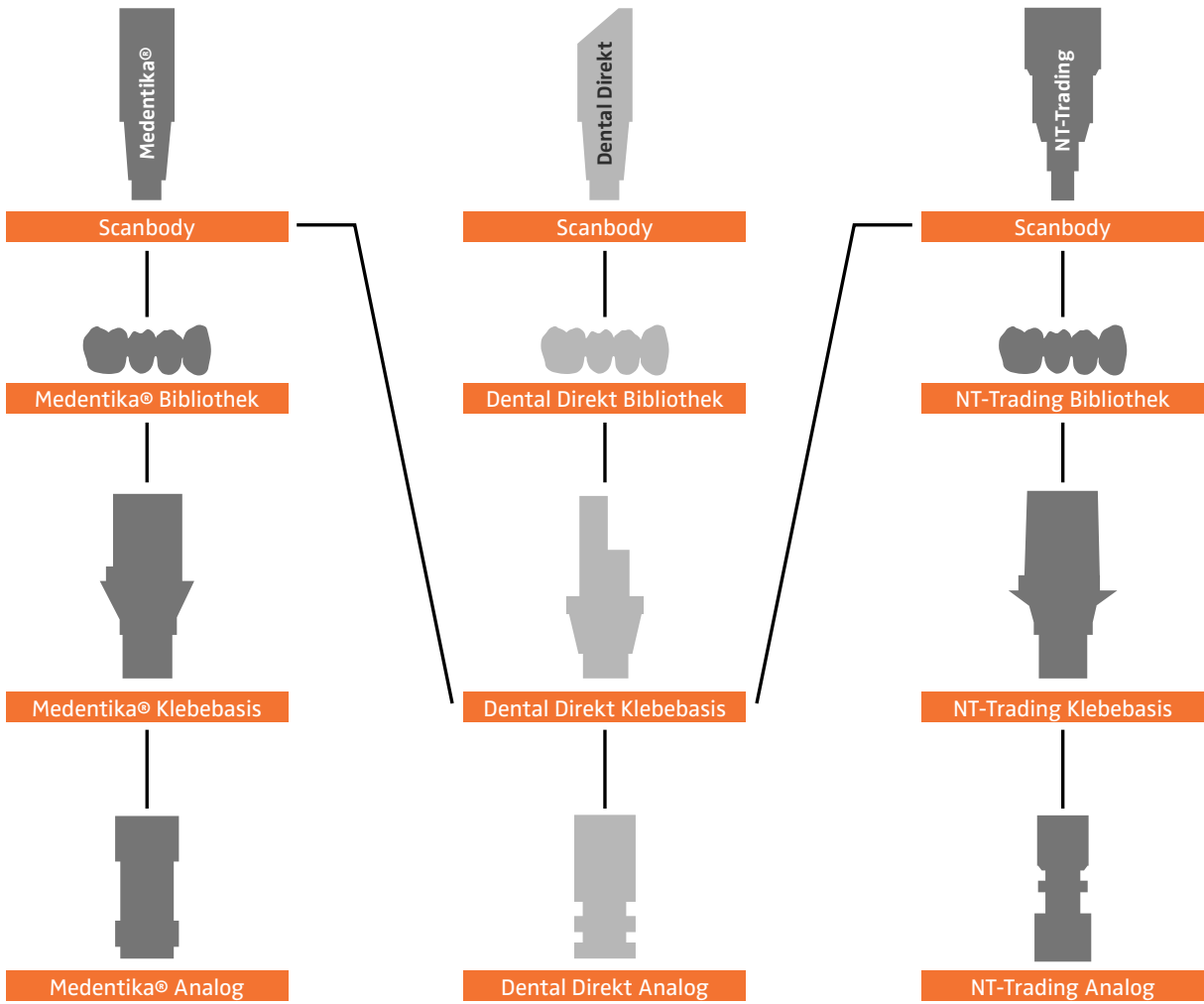
Verwendung

- Verwendung der original Laborschraube möglich
- **Kombianalog:** Einsetzbar im 3D Modell und im Gipsmodell

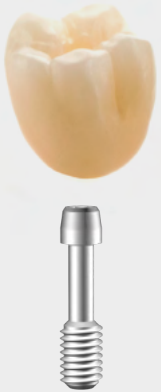





Scanbody Modell	Scanbody intraoral	Hybridabutment plus Zirkonoxidkrone, verschraubt oder zementiert
<p data-bbox="284 526 459 560">DD Lab Screw</p> 	<p data-bbox="722 526 946 560">DD Implant Screw</p> 	
<p data-bbox="263 996 483 1030">DD Scanbody 2.0</p> 	<p data-bbox="722 996 946 1030">DD Scanbody 2.0</p> 	<p data-bbox="1193 996 1409 1030">DD Ti-Base 2CUT</p>  <p data-bbox="1106 1384 1273 1417">Titanklebebasis</p> <p data-bbox="1337 1350 1465 1417">Zirkonoxid- anteil</p>
<p data-bbox="260 1507 486 1541">DD Fusion Analog</p> 		

Zirkonoxidbrücke,
verschraubt oder zementiert

Zirkonoxidkrone

Individuelles Abutment plus
Zirkonoxidkrone, verschraubt
oder zementiert

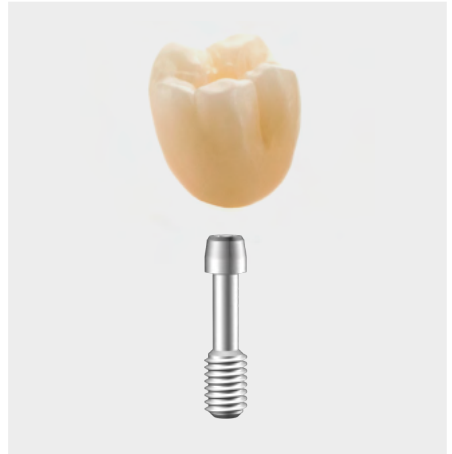
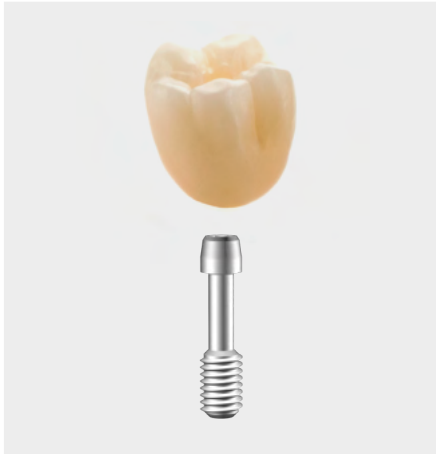

DD Ti-Base 2CUT noLock

DD Ti-Base 2CUT

DD Prefab

Individuelles
Abutment



DENTSPLY Implants®
Astra Tech TX

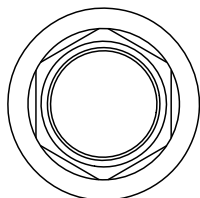

AAS-Serie

Bredent Medical
Sky®

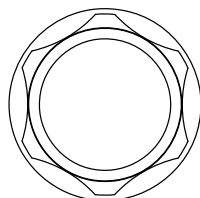

BSK-Serie

Altatec
Camlog®

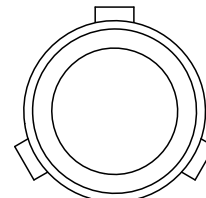

CCA-Serie

MegaGen
AnyRidge®

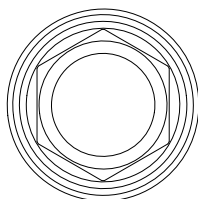

MAR-Serie

Medentis Medical®
ICX

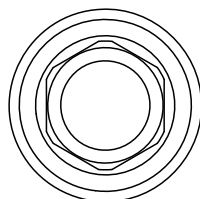

MMI-Serie

MIS Implants®
Seven®

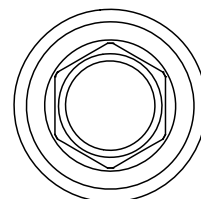

MSE-Serie

Osstem Implant
TS

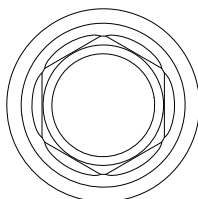

OTS-Serie

Straumann®
Bone Level®

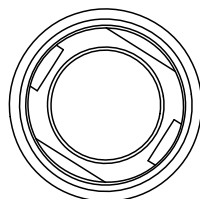

SBO-Serie

Straumann®
Tissue Level

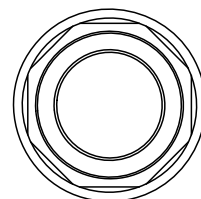

SSY-Serie

Altatec
Conelog®

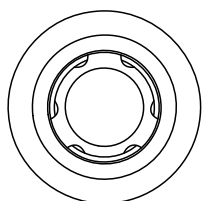

CCO-Serie

DENTSPLY Implants®
Astra EV

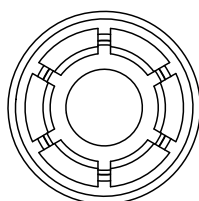

DEV-Serie

DENTSPLY Implants®
Frialit® / Xive®

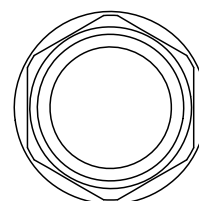

DFX-Serie

Nobel Biocare™
Brånemark™

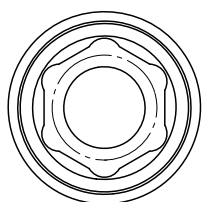

NBR-Serie

Nobel Biocare™
Nobel Active®

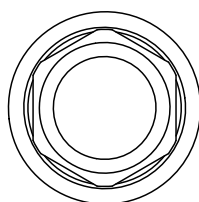

NNA-Serie

Nobel Biocare™
Replace Select®

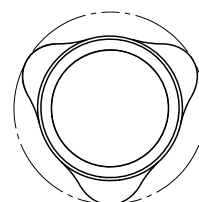

NRE-Serie

Thommen Medical
SPI®

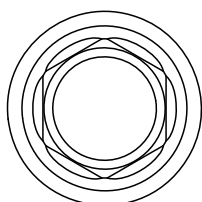

TSP-Serie

Zimmer Biomet 3i
Certain®

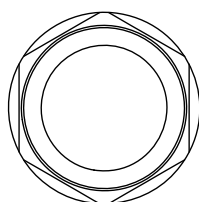

ZBC-Serie



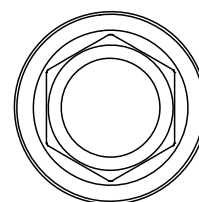



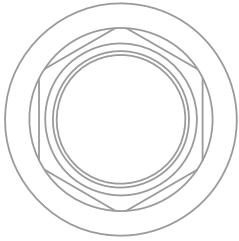

Zimmer Dental
Tapered Screw-Vent®

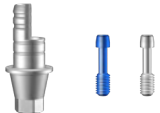

ZTA-Serie



3.5 – 5.0 mm

	Ø 3.5/4.0 mm	Ø 4.5/5.0 mm	Preis (Euro/netto)
DD Prefab (inkl. Implantatschraube und Laborschraube)			29,90 €
	DDAASPF35S	DDAASPF45S	
DD Prefab – kompatibel zu MEDENTIKA S-Serie – Ø 11,5 mm (inkl. Implantatschraube und Laborschraube)			29,90 €
	MDKAASPF35S	MDKAASPF45S	
DD Ti-Base 2CUT (inkl. Implantatschraube und Laborschraube)			39,90 €
	DDAASKL35S	DDAASKL45S	
DD Ti-Base 2CUT noLock (inkl. Implantatschraube und Laborschraube)			39,90 €
	DDAASNL35S	DDAASNL45S	
DD Scanbody 2.0 (inkl. Implantatschraube und Laborschraube)			29,90 €
	DDAASST35S	DDAASST45S	
DD Fusion Analog			14,90 €
	DDAASDA35	DDAASDA45	
DD Lab Screw			6,00 €
	DDAASLS35	DDAASLS45	
Drehmoment Laborschraube (blau anodisiert)	10 Ncm	10 Ncm	
DD Implant Screw			9,90 €
	DDAASIS35	DDAASIS45	
Drehmoment Implantatschraube (silber)	25 Ncm	25 Ncm	
Eindrehinstrument:	Laborschraube: Torx T6 – Implantatschraube: Hex 1,3		

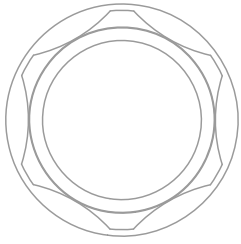

3.5 – 5.5 mm

Ø 3.5 – 5.5 mm

Preis (Euro/netto)

DD Prefab (inkl. Implantatschraube und Laborschraube)

29,90 €



DDBSKPF35S

DD Prefab – kompatibel zu MEDENTIKA B-Serie – Ø 11,5 mm (inkl. Implantatschraube und Laborschraube)

29,90 €



3,5 mm – MDKBSKPF35S

4,5 mm – MDKBSKPF40S

DD Ti-Base 2CUT (inkl. Implantatschraube und Laborschraube)

39,90 €

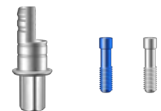

DDBSKKL35S

DD Ti-Base 2CUT noLock (inkl. Implantatschraube und Laborschraube)

39,90 €



DDBSKNL35S

DD Scanbody 2.0 (inkl. Implantatschraube und Laborschraube)

29,90 €



DDBSKST35S

DD Fusion Analog

14,90 €



DDBSKDA35

DD Lab Screw

6,00 €



DDBSKLS40

Drehmoment
Laborschraube (blau anodisiert)

10 Ncm

DD Implant Screw

9,90 €



DDBSKIS40

Drehmoment
Implantatschraube (silber)







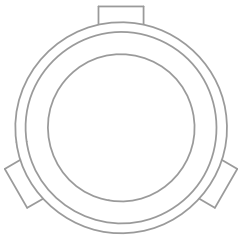

25 Ncm

Eindrehinstrument:

Laborschraube: Torx T6 – Implantatschraube: Torx SKY







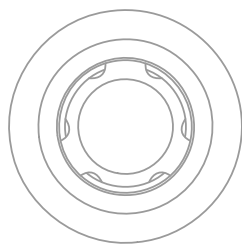

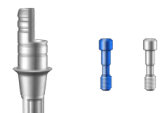

3.3 – 5.0 mm

	Ø 3.3 mm	Ø 3.8 mm	Ø 4.3 mm	Ø 5.0 mm	Preis (Euro/netto)
DD Prefab (inkl. Implantatschraube und Laborschraube)					29,90 €
	DDCCAPF33S	DDCCAPF38S	DDCCAPF43S	DDCCAPF50S	
DD Prefab – kompatibel zu MEDITIKA C-Serie – Ø 11,5 mm (inkl. Implantatschraube und Laborschraube)					29,90 €
	MDKCCAPF33S	MDKCCAPF38S	MDKCCAPF43S	MDKCCAPF50S	
DD Ti-Base 2CUT (inkl. Implantatschraube und Laborschraube)					39,90 €
	DDCCAKL33S	DDCCAKL38S	DDCCAKL43S	DDCCAKL50S	
DD Ti-Base 2CUT noLock (inkl. Implantatschraube und Laborschraube)					39,90 €
	DDCCANL33S	DDCCANL38S	DDCCANL43S	DDCCANL50S	
DD Scanbody 2.0 (inkl. Implantatschraube und Laborschraube)					29,90 €
	DDCCAST33S	DDCCAST38S	DDCCAST43S	DDCCAST50S	
DD Fusion Analog					14,90 €
	DDCCADA33	DDCCADA38	DDCCADA43	DDCCADA50	
DD Lab Screw					6,00 €
	DDCCALS43	DDCCALS43	DDCCALS43	DDCCALS50	
Drehmoment Laborschraube (blau anodisiert)	10 Ncm	10 Ncm	10 Ncm	10 Ncm	
DD Implant Screw					9,90 €
	DDCCAIS43	DDCCAIS43	DDCCAIS43	DDCCAIS50	
Drehmoment Implantatschraube (silber)	20 Ncm	20 Ncm	20 Ncm	20 Ncm	
Eindrehinstrument:	Laborschraube: Torx T6 – Implantatschraube: Hex 0.05"				

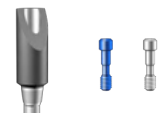





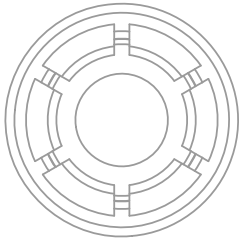



3.3 – 5.0 mm

	Ø 3.3 mm	Ø 3.8 mm	Ø 4.3 mm	Ø 5.0 mm	Preis (Euro/netto)
DD Prefab (inkl. Implantatschraube und Laborschraube)					29,90 €
	DDCCOPF33S	DDCCOPF38S	DDCCOPF43S	DDCCOPF50S	
DD Prefab – kompatibel zu MEDITIKA D-Serie – Ø 11,5 mm (inkl. Implantatschraube und Laborschraube)					29,90 €
	MDKCCOPF33S	3,8/4,3 – MDKCCOPF38S	–		
DD Ti-Base 2CUT (inkl. Implantatschraube und Laborschraube)					39,90 €
	DDCCOKL33S	DDCCOKL38S	DDCCOKL43S	DDCCOKL50S	
DD Ti-Base 2CUT noLock (inkl. Implantatschraube und Laborschraube)					39,90 €
	DDCCONL33S	DDCCONL38S	DDCCONL43S	DDCCONL50S	
DD Scanbody 2.0 (inkl. Implantatschraube und Laborschraube)					29,90 €
	DDCCOST33S	DDCCOST38S	DDCCOST43S	DDCCOST50S	
DD Fusion Analog					14,90 €
	DDCCODA33	DDCCODA38	DDCCODA43	DDCCODA50	
DD Lab Screw					6,00 €
	DDCCOLS43	DDCCOLS43	DDCCOLS43	DDCCOLS50	
Drehmoment Laborschraube (blau anodisiert)	10 Ncm	10 Ncm	10 Ncm	10 Ncm	
DD Implant Screw					9,90 €
	DDCCOIS43	DDCCOIS43	DDCCOIS43	DDCCOIS50	
Drehmoment Implantatschraube (silber)	20 Ncm	20 Ncm	20 Ncm	20 Ncm	
Eindrehinstrument:	Laborschraube: Torx T6 – Implantatschraube: Hex 0.05"				







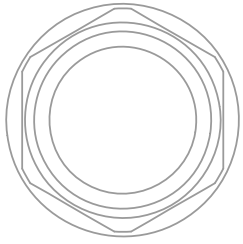

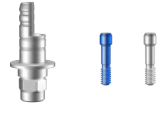

3.0 – 5.4 mm

	Ø 3.0 mm	Ø 3.6 mm	Ø 4.2 mm	Ø 4.8 mm	Ø 5.4 mm	Preis (Euro/netto)
DD Prefab (inkl. Implantatschraube und Laborschraube)						29,90 €
	DDDEVPF30S	DDDEVPF36S	DDDEVPF42S	DDDEVPF48S	DDDEVPF54S	
DD Prefab – kompatibel zu MEDENTIKA EV-Serie – Ø 11,5 mm (inkl. Implantatschraube und Laborschraube)						29,90 €
	MDKDEVPF30S	MDKDEVPF36S	MDKDEVPF42S	MDKDEVPF48S	MDKDEVPF54S	
DD Ti-Base 2CUT (inkl. Implantatschraube und Laborschraube)						39,90 €
	DDDEVKL30S	DDDEVKL36S	DDDEVKL42S	DDDEVKL48S	DDDEVKL54S	
DD Ti-Base 2CUT noLock (inkl. Implantatschraube und Laborschraube)						39,90 €
	DDDEVNL30S	DDDEVNL36S	DDDEVNL42S	DDDEVNL48S	DDDEVNL54S	
DD Scanbody 2.0 (inkl. Implantatschraube und Laborschraube)						29,90 €
	DDDEVST30S	DDDEVST36S	DDDEVST42S	DDDEVST48S	DDDEVST54S	
DD Fusion Analog						14,90 €
	DDDEVDA30	DDDEVDA36	DDDEVDA42	DDDEVDA48	DDDEVDA54	
DD Lab Screw						6,00 €
	DDDEVLS30	DDDEVLS36	DDDEVLS42	DDDEVLS54	DDDEVLS54	
Drehmoment Laborschraube (blau anodisiert)	10 Ncm	10 Ncm	10 Ncm	10 Ncm	10 Ncm	
DD Implant Screw						9,90 €
	DDDEVIS30	DDDEVIS36	DDDEVIS42	DDDEVIS54	DDDEVIS54	
Drehmoment Implantatschraube (silber)	25 Ncm	25 Ncm	25 Ncm	25 Ncm	25 Ncm	
Eindrehinstrument:	Laborschraube: Torx T6 – Implantatschraube: Hex 1,3					







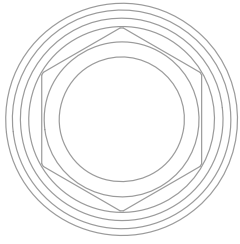

3.4 – 5.5 mm

	Ø 3.4 mm	Ø 3.8 mm	Ø 4.5 mm	Ø 5.5 mm	Preis (Euro/netto)
DD Prefab (inkl. Implantatschraube und Laborschraube)					29,90 €
 DDDFXPF34S		DDDFXP38S	DDDFXP45S	DDDFXP55S	
DD Prefab – kompatibel zu MEDENTIKA T-Serie – Ø 11,5 mm (inkl. Implantatschraube und Laborschraube)					29,90 €
 MDKDFXP34S		MDKDFXP38S	MDKDFXP45S	–	
DD Ti-Base 2CUT (inkl. Implantatschraube und Laborschraube)					39,90 €
 DDDFXKL34S		DDDFXKL38S	DDDFXKL45S	DDDFXKL55S	
DD Ti-Base 2CUT noLock (inkl. Implantatschraube und Laborschraube)					39,90 €
 DDDFXNL34S		DDDFXNL38S	DDDFXNL45S	DDDFXNL55S	
DD Scanbody 2.0 (inkl. Implantatschraube und Laborschraube)					29,90 €
 DDDFXST34S		DDDFXST38S	DDDFXST45S	DDDFXST55S	
DD Fusion Analog					14,90 €
 DDDFXDA34		DDDFXDA38	DDDFXDA45	DDDFXDA55	
DD Lab Screw					6,00 €
 DDDFXLS55		DDDFXLS55	DDDFXLS55	DDDFXLS55	
Drehmoment Laborschraube (blau anodisiert)	10 Ncm	10 Ncm	10 Ncm	10 Ncm	
DD Implant Screw					9,90 €
 DDDFXIS55		DDDFXIS55	DDDFXIS55	DDDFXIS55	
Drehmoment Implantatschraube (silber)	25 Ncm	25 Ncm	25 Ncm	25 Ncm	
Eindrehinstrument:	Laborschraube: Torx T6 – Implantatschraube: Hex 1,22				

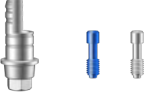
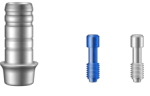





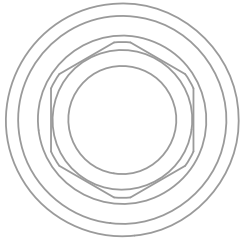



3.5 – 8.0 mm

Ø 3.5 – 8.0 mm		Preis (Euro/netto)
DD Prefab (inkl. Implantatschraube und Laborschraube)		29,90 €
	DDMARPF35S	
DD Prefab – kompatibel zu MEDENTIKA MG-Serie – Ø 11,5 mm (inkl. Implantatschraube und Laborschraube)		29,90 €
	MDKMARPF35S	
DD Ti-Base 2CUT (inkl. Implantatschraube und Laborschraube)		39,90 €
	DDMARKL35S	
DD Ti-Base 2CUT noLock (inkl. Implantatschraube und Laborschraube)		39,90 €
	DDMARNL35S	
DD Scanbody 2.0 (inkl. Implantatschraube und Laborschraube)		29,90 €
	DDMARST35S	
DD Fusion Analog		14,90 €
	DDMARDA35	
DD Lab Screw		6,00 €
	DDMARLS35	
Drehmoment Laborschraube (blau anodisiert)	10 Ncm	
DD Implant Screw		9,90 €
	DDMARIS35	
Drehmoment Implantatschraube (silber)	30 Ncm	
Eindrehinstrument:	Laborschraube: Torx T6 – Implantatschraube: Hex 1,2	







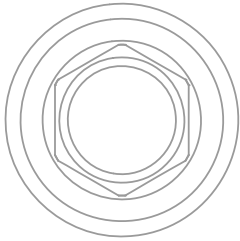

3.75 – 4.8 mm

		Ø 3.75 – 4.8 mm	Preis (Euro/netto)
DD Prefab (inkl. Implantatschraube und Laborschraube)			29,90 €
	DDMMIPF41S		
DD Prefab – kompatibel zu MEDENTIKA CX-Serie – Ø 11,5 mm (inkl. Implantatschraube und Laborschraube)			29,90 €
	MDKMMIPF41S		
DD Ti-Base 2CUT (inkl. Implantatschraube und Laborschraube)			39,90 €
	DDMMIKL41S		
DD Ti-Base 2CUT noLock (inkl. Implantatschraube und Laborschraube)			39,90 €
	DDMMINL41S		
DD Scanbody 2.0 (inkl. Implantatschraube und Laborschraube)			29,90 €
	DDMMIST41S		
DD Fusion Analog			14,90 €
	DDMMIDA41		
DD Lab Screw			6,00 €
	DDMMILS41		
Drehmoment Laborschraube (blau anodisiert)	10 Ncm		
DD Implant Screw			9,90 €
	DDMMIIS41		
Drehmoment Implantatschraube (silber)	30 Ncm		
Eindrehinstrument:	Laborschraube: Torx T6 – Implantatschraube: Hex 1,4		







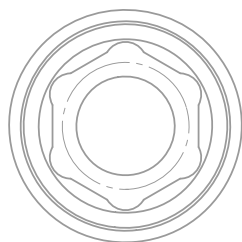



3.3 – 5.0 mm

	Ø 3.3 mm (NP)	Ø 3.75/4.2 mm (SP)	Ø 5.0 mm (WP)	Preis (Euro/netto)
DD Prefab (inkl. Implantatschraube und Laborschraube)				29,90 €
	DDMSEPF33S	DDMSEPF42S	DDMSEPF50S	
DD Ti-Base 2CUT (inkl. Implantatschraube und Laborschraube)				39,90 €
	DDMSEKL33S	DDMSEKL42S	DDMSEKL50S	
DD Ti-Base 2CUT noLock (inkl. Implantatschraube und Laborschraube)				39,90 €
	DDMSENL33S	DDMSENL42S	DDMSENL50S	
DD Scanbody 2.0 (inkl. Implantatschraube und Laborschraube)				29,90 €
	DDMSEST33S	DDMSEST42S	DDMSEST50S	
DD Fusion Analog				14,90 €
	DDMSEDA33	DDMSEDA42	DDMSEDA50	
DD Lab Screw				6,00 €
	DDMSELS33	DDMSELS50	DDMSELS50	
Drehmoment Laborschraube (blau anodisiert)	10 Ncm	10 Ncm	10 Ncm	
DD Implant Screw				9,90 €
	DDMSEIS33	DDMSEIS50	DDMSEIS50	
Drehmoment Implantatschraube (silber)	30 Ncm	30 Ncm	30 Ncm	
Eindrehinstrument:	Laborschraube: Torx T6 – Implantatschraube: Hex 0.05"			







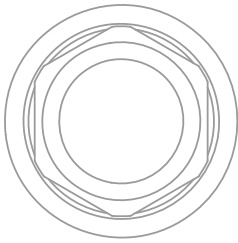













3.5 – 4.1 mm

	Ø 3.5 mm (NP)	Ø 4.1 mm (RP)	Preis (Euro/netto)
DD Prefab (inkl. Implantatschraube und Laborschraube)			29,90 €
	DDNBRPF35S	DDNBRPF41S	
DD Prefab – kompatibel zu MEDENTIKA K-Serie – Ø 11,5 mm (inkl. Implantatschraube und Laborschraube)			29,90 €
	MDKNBRPF35S	MDKNBRPF41S	
DD Ti-Base 2CUT (inkl. Implantatschraube und Laborschraube)			39,90 €
	DDNBRKL35S	DDNBRKL41S	
DD Ti-Base 2CUT noLock (inkl. Implantatschraube und Laborschraube)			39,90 €
	DDNBRNL35S	DDNBRNL41S	
DD Scanbody 2.0 (inkl. Implantatschraube und Laborschraube)			29,90 €
	DDNBRST35S	DDNBRST41S	
DD Fusion Analog			14,90 €
	DDNBRDA35	DDNBRDA41	
DD Lab Screw			6,00 €
	DDNBRLS35	DDNBRLS41	
Drehmoment Laborschraube (blau anodisiert)	10 Ncm	10 Ncm	
DD Implant Screw			9,90 €
	DDNBRIS35	DDNBRIS41	
Drehmoment Implantatschraube (silber)	35 Ncm	35 Ncm	
Eindrehinstrument:	Laborschraube: Torx T6 – Implantatschraube: Unigrip		







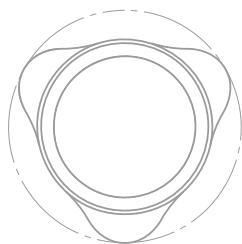

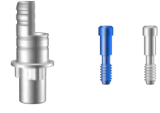

3.5 – 5.0 mm

	Ø 3.5 mm (NP)	Ø 4.3/5.0 mm (RP)	Preis (Euro/netto)
DD Prefab (inkl. Implantatschraube und Laborschraube)			29,90 €
  	DDNNAPF35S	DDNNAPF43S	
DD Prefab – kompatibel zu MEDITIKA F-Serie – Ø 11,5 mm (inkl. Implantatschraube und Laborschraube)			29,90 €
  	MDKNNAPF35S	MDKNNAPF43S	
DD Ti-Base 2CUT (inkl. Implantatschraube und Laborschraube)			39,90 €
  	DDNNAKL35S	DDNNAKL43S	
DD Ti-Base 2CUT noLock (inkl. Implantatschraube und Laborschraube)			39,90 €
  	DDNNANL35S	DDNNANL43S	
DD Scanbody 2.0 (inkl. Implantatschraube und Laborschraube)			29,90 €
  	DDNNAST35S	DDNNAST43S	
DD Fusion Analog			14,90 €
	DDNNADA35	DDNNADA43	
DD Lab Screw			6,00 €
	DDNNALS35	DDNNALS43	
Drehmoment Laborschraube (blau anodisiert)	10 Ncm	10 Ncm	
DD Implant Screw			9,90 €
	DDNNAIS35	DDNNAIS43	
Drehmoment Implantatschraube (silber)	25 Ncm	35 Ncm	
Eindrehinstrument:	Laborschraube: Torx T6 – Implantatschraube: Unigrip		







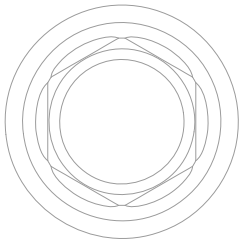

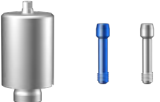

3.5 – 5.0 mm

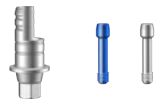
	Ø 3.5 mm (NP)	Ø 4.3 mm (RP)	Ø 5.0 mm (WP)	Preis (Euro/netto)
DD Prefab (inkl. Implantatschraube und Laborschraube)				29,90 €
	DDNREPF35S	DDNREPF43S	DDNREPF50S	
DD Prefab – kompatibel zu MEDENTIKA E-Serie – Ø 11,5 mm (inkl. Implantatschraube und Laborschraube)				29,90 €
	MDKNREPF35S	MDKNREPF43S	MDKNREPF50S	
DD Ti-Base 2CUT (inkl. Implantatschraube und Laborschraube)				39,90 €
	DDNREKL35S	DDNREKL43S	DDNREKL50S	
DD Ti-Base 2CUT noLock (inkl. Implantatschraube und Laborschraube)				39,90 €
	DDNRENL35S	DDNRENL43S	DDNRENL50S	
DD Scanbody 2.0 (inkl. Implantatschraube und Laborschraube)				29,90 €
	DDNREST35S	DDNREST43S	DDNREST50S	
DD Fusion Analog				14,90 €
	DDNREDA35	DDNREDA43	DDNREDA50	
DD Lab Screw				6,00 €
	DDNRELS35	DDNRELS50	DDNRELS50	
Drehmoment Laborschraube (blau anodisiert)	10 Ncm	10 Ncm	10 Ncm	
DD Implant Screw				9,90 €
	DDNREIS35	DDNREIS50	DDNREIS50	
Drehmoment Implantatschraube (silber)	35 Ncm	35 Ncm	35 Ncm	
Eindrehinstrument:	Laborschraube: Torx T6 – Implantatschraube: Unigrip			



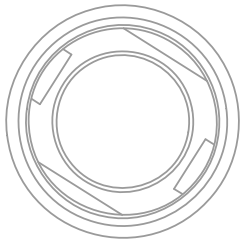

3.5 – 6.0 mm

	Ø 3.5 mm (M)	Ø 4.0 – 6.0 mm (R)	Preis (Euro/netto)
DD Prefab (inkl. Implantatschraube und Laborschraube)			29,90 €
	DDOTSPF35S	DDOTSPF40S	
DD Prefab – kompatibel zu MEDITIKA OT-Serie – Ø 11,5 mm (inkl. Implantatschraube und Laborschraube)			29,90 €
	MDKOTSPF35S	MDKOTSPF40S	
DD Ti-Base 2CUT (inkl. Implantatschraube und Laborschraube)			39,90 €
	DDOTSKL35S	DDOTSKL40S	
DD Ti-Base 2CUT noLock (inkl. Implantatschraube und Laborschraube)			39,90 €
	DDOTSNL35S	DDOTSNL40S	
DD Scanbody 2.0 (inkl. Implantatschraube und Laborschraube)			29,90 €
	DDOTSST35S	DDOTSST40S	
DD Fusion Analog			14,90 €
	DDOTSDA35	DDOTSDA40	
DD Lab Screw			6,00 €
	DDOTSLS35	DDOTSLS40	
Drehmoment Laborschraube (blau anodisiert)	10 Ncm	10 Ncm	
DD Implant Screw			9,90 €
	DDOTSIS35	DDOTSIS40	
Drehmoment Implantatschraube (silber)	20 Ncm	20 Ncm	
Eindrehinstrument:	Laborschraube: Torx T6 – Implantatschraube: Hex 1,2		



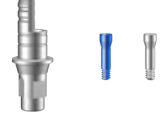



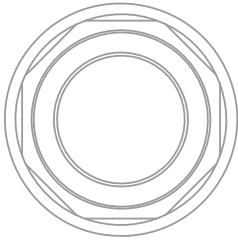



3.3 – 4.8 mm

	Ø 3.3 mm (NC)	Ø 4.1/4.8 mm (RC)	Preis (Euro/netto)
DD Prefab (inkl. Implantatschraube und Laborschraube)			29,90 €
	DDSBOPF33S	DDSBOPF41S	
DD Prefab – kompatibel zu MEDENTIKA L-Serie – Ø 11,5 mm (inkl. Implantatschraube und Laborschraube)			29,90 €
	MDKSBOPF33S	MDKSBOPF41S	
DD Ti-Base 2CUT (inkl. Implantatschraube und Laborschraube)			39,90 €
	DDSBOKL33S	DDSBOKL41S	
DD Ti-Base 2CUT noLock (inkl. Implantatschraube und Laborschraube)			39,90 €
	DDSBONL33S	DDSBONL41S	
DD Scanbody 2.0 (inkl. Implantatschraube und Laborschraube)			29,90 €
	DDSBOST33S	DDSBOST41S	
DD Fusion Analog			14,90 €
	DDSBODA33	DDSBODA41	
DD Lab Screw			6,00 €
	DDSBOLS33	DDSBOLS41	
Drehmoment Laborschraube (blau anodisiert)	10 Ncm	10 Ncm	
DD Implant Screw			9,90 €
	DDSBOIS33	DDSBOIS41	
Drehmoment Implantatschraube (silber)	35 Ncm	35 Ncm	
Eindrehinstrument:	Laborschraube: Torx T6 – Implantatschraube: Torx T6		







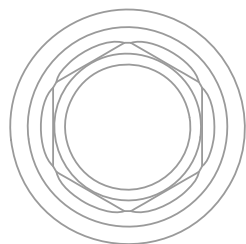

4.8 – 6.5 mm

	Ø 4.8 mm (RN)	Ø 6.5 mm (WN)	Preis (Euro/netto)
DD Prefab (inkl. Implantatschraube und Laborschraube)			29,90 €
	DDSSYPF48S	DDSSYPF65S	
DD Prefab – kompatibel zu MEDENTIKA N-Serie – Ø 11,5 mm (inkl. Implantatschraube und Laborschraube)			29,90 €
	MDKSSYPF48S	MDKSSYPF65S	
DD Ti-Base 2CUT (inkl. Implantatschraube und Laborschraube)			39,90 €
	DDSSYKL48S	DDSSYKL65S	
DD Ti-Base 2CUT noLock (inkl. Implantatschraube und Laborschraube)			39,90 €
	DDSSYNL48S	DDSSYNL65S	
DD Scanbody 2.0 (inkl. Implantatschraube und Laborschraube)			29,90 €
	DDSSYST48S	DDSSYST65S	
DD Fusion Analog			14,90 €
	DDSSYDA48	DDSSYDA65	
DD Lab Screw			6,00 €
	DDSSYLS65	DDSSYLS65	
Drehmoment Laborschraube (blau anodisiert)	10 Ncm	10 Ncm	
DD Implant Screw			9,90 €
	DDSSYIS65	DDSSYIS65	
Drehmoment Implantatschraube (silber)	35 Ncm	35 Ncm	
Eindrehinstrument:	Laborschraube: Torx T6 – Implantatschraube: Torx T6		







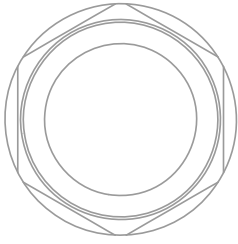

4.0 – 6.0 mm

	Ø 4.0 mm	Ø 4.5 mm	Ø 5.0 mm	Ø 6.0 mm	Preis (Euro/netto)
DD Prefab (inkl. Implantatschraube und Laborschraube)					29,90 €
	DDTSPPF40S	DDTSPPF45S	DDTSPPF50S	DDTSPPF60S	
DD Ti-Base 2CUT (inkl. Implantatschraube und Laborschraube)					39,90 €
	DDTSPKL40S	DDTSPKL45S	DDTSPKL50S	DDTSPKL60S	
DD Ti-Base 2CUT noLock (inkl. Implantatschraube und Laborschraube)					39,90 €
	DDTSPNL40S	DDTSPNL45S	DDTSPNL50S	DDTSPNL60S	
DD Scanbody 2.0 (inkl. Implantatschraube und Laborschraube)					29,90 €
	DDTSPST40S	DDTSPST45S	DDTSPST50S	DDTSPST60S	
DD Fusion Analog					14,90 €
	DDTSPDA40	DDTSPDA45	DDTSPDA50	DDTSPDA60	
DD Lab Screw					6,00 €
	DDTSPLS40	DDTSPLS45	DDTSPLS50	DDTSPLS60	
Drehmoment Laborschraube (blau anodisiert)	10 Ncm	10 Ncm	10 Ncm	10 Ncm	
DD Implant Screw					9,90 €
	DDTSPIS40	DDTSPIS45	DDTSPIS50	DDTSPIS60	
Drehmoment Implantatschraube (silber)	25 Ncm	25 Ncm	25 Ncm	25 Ncm	
Eindrehinstrument:	Laborschraube: Torx T6 – Implantatschraube: 4-lobe				

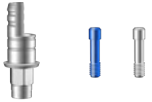
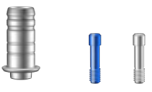





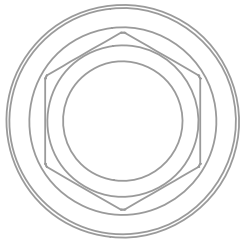

3.4 – 5.0 mm

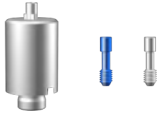
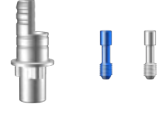
	Ø 3.4 mm	Ø 4.1/5.0 mm	Preis (Euro/netto)
DD Prefab (inkl. Implantatschraube und Laborschraube)			29,90 €
	DDZBCPF34S	DDZBCPF41S	
DD Prefab – kompatibel zu MEDITIKA H-Serie – Ø 11,5 mm (inkl. Implantatschraube und Laborschraube)			29,90 €
	MDKZBCPF34S	MDKZBCPF41S	
DD Ti-Base 2CUT (inkl. Implantatschraube und Laborschraube)			39,90 €
	DDZBCKL34S	DDZBCKL41S	
DD Ti-Base 2CUT noLock (inkl. Implantatschraube und Laborschraube)			39,90 €
	DDZBCNL34S	DDZBCNL41S	
DD Scanbody 2.0 (inkl. Implantatschraube und Laborschraube)			29,90 €
	DDZBCST34S	DDZBCST41S	
DD Fusion Analog			14,90 €
	DDZBCDA34	DDZBCDA41	
DD Lab Screw			6,00 €
	DDZBCLS50	DDZBCLS50	
Drehmoment Laborschraube (blau anodisiert)	10 Ncm	10 Ncm	
DD Implant Screw			9,90 €
	DDZBCIS50	DDZBCIS50	
Drehmoment Implantatschraube (silber)	30 Ncm	30 Ncm	
Eindrehinstrument:	Laborschraube: Torx T6 – Implantatschraube: Hex 1,22		



3.5 – 5.7 mm

	Ø 3.5 mm	Ø 4.5 mm	Ø 5.7 mm	Preis (Euro/netto)
DD Prefab (inkl. Implantatschraube und Laborschraube)				29,90 €
	DDZTAPF35S	DDZTAPF45S	DDZTAPF57S	
DD Ti-Base 2CUT (inkl. Implantatschraube und Laborschraube)				39,90 €
	DDZTAKL35S	DDZTAKL45S	DDZTAKL57S	
DD Ti-Base 2CUT noLock (inkl. Implantatschraube und Laborschraube)				39,90 €
	DDZTANL35S	DDZTANL45S	DDZTANL57S	
DD Scanbody 2.0 (inkl. Implantatschraube und Laborschraube)				29,90 €
	DDZTAST35S	DDZTAST45S	DDZTAST57S	
DD Fusion Analog				14,90 €
	DDZTADA35	DDZTADA45	DDZTADA57	
DD Lab Screw				6,00 €
	DDZTALS57	DDZTALS57	DDZTALS57	
Drehmoment Laborschraube (blau anodisiert)	10 Ncm	10 Ncm	10 Ncm	
DD Implant Screw				9,90 €
	DDZTAIS57	DDZTAIS57	DDZTAIS57	
Drehmoment Implantatschraube (silber)	30 Ncm	30 Ncm	30 Ncm	
Eindrehinstrument:	Laborschraube: Torx T6 – Implantatschraube: Hex Driver 1,25			

CORiTEC, 3 mm oder 6 mm Schaftwerkzeuge

Preis (Euro/netto)

DD Prefab Starter Kit

790,00 €



CAM 0511
für 6 mm
Schaftwerkzeuge

CAM 0511.01
für 3 mm
Schaftwerkzeuge

- 1 x Ringhalter
- 2 x Riegel
- 4 x M4 Schrauben
- 6 x M4 Schrauben
- 6 x M4 Senkkopfschrauben
- 1 x Schraubendreher SW 3 mm
- 1 x Schraubendreher SW 2,5 mm
- 1 x Kalibrierfräser
- 5 x Kalibrierkörper
- 6 x Prefabs Ihrer Wahl

DD Prefab Halter

369,00 €

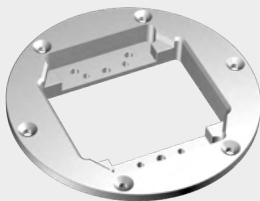

CAM 0511.3

- 1 x Ringhalter
- 6 x M4 Senkkopfschrauben

MB

Preis (Euro/netto)

DD Prefab Starter Kit MB

790,00 €



CAM 0517

- 1 x Ringhalter
- 2 x Riegel
- 4 x M4 Schrauben
- 6 x M4 Schrauben
- 1 x Schraubendreher SW 3 mm
- 5 x Kalibrierkörper
- 6 x Prefabs Ihrer Wahl

DD Prefab Halter MB (Ring)

369,00 €

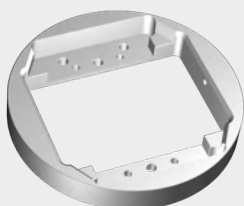

CAM 0518

- 1 x Ringhalter

SilaMill (vhf) Preis (Euro/netto)

DD Prefab Starter Kit SilaMill N4 **490,00 €**



CAM 1101.5

- 1 x Halter SilaMill N4
- 1 x Riegel
- 4 x M4 Schrauben
- 3 x M4 Schrauben
- 1 x Schraubendreher SW 3 mm
- 3 x Kalibrierkörper
- 3 x Prefabs Ihrer Wahl

DD Prefab Halter SilaMill N4 **249,00 €**

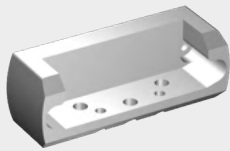

CAM 1101.4

- 1 x Halter
- 2 x M4 Senkkopfschrauben

SilaMill (vhf) Preis (Euro/netto)

DD Prefab Starter Kit SilaMill R5 **790,00 €**



CAM 1104.4



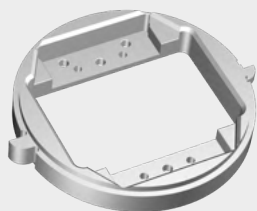

- 1 x Halter SilaMill R5
- 2 x Riegel
- 4 x M4 Schrauben
- 6 x M4 Schrauben
- 1 x Schraubendreher SW 3 mm
- 1 x Schraubendreher SW 2,5 mm
- 5 x Kalibrierkörper
- 6 x Prefabs Ihrer Wahl

DD Prefab Halter SilaMill R5 **369,00 €**

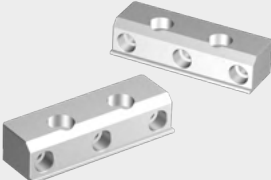

CAM 1104.3

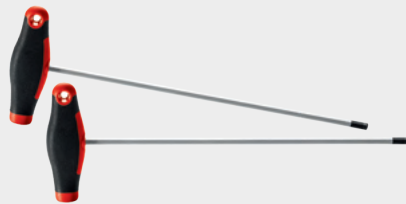
- 1 x Ringhalter

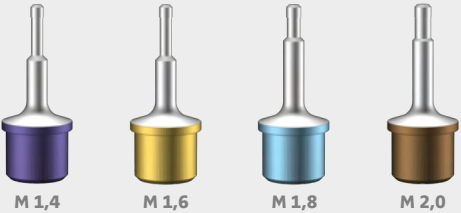
Zubehör		Preis (Euro/netto)
DD Prefab-Adapter (Riegel)		199,00 €
	CAM 0511.5 2 x Riegel 4 x M4 Schrauben, schwarz 6 x M4 Schrauben, silber Kompatibel mit allen Systemen	
Kalibrierkörper		6,00 €
	CAM 0511.7 1 x Kalibrierkörper	
Schraubendreher (Halter)		14,50 €
	CAM 0511.1 1 x Schraubendreher SW 2,5 mm CAM 0511.2 1 x Schraubendreher SW 3 mm	
DD Ti-Base 2CUT holder		19,90 €
	CAM 0515 small CAM 0516 large	
DD Einbringhilfe (3D Druck) – Fusion Analog		49,90 €
 <p>M 1,4 M 1,6 M 1,8 M 2,0</p>	DDIAFASET DD Einbringhilfe Set DD Einbringhilfe (einzeln) DDIAFAM14 M 1,4 (Ø 3,0 – 3,5) DDIAFAM16 M 1,6 (Ø 3,6 – 4,0) DDIAFAM18 M 1,8 (Ø 4,1 – 4,5) DDIAFAM20 M 2,0 (Ø 5,1 – 6,5)	15,90 €



Dieter Neunzig
Produktmanager Implantatkomponenten

05428 501 68-587
d.neunzig@dentaldirekt.de



Sandro de Punzio
Technischer Vertriebsmanager

0170 781 45 33
s.depunzio@dentaldirekt.de



Sebastian Kleingödinghaus
Leitung technischer Support

05428 501 68-30
s.kleingoedinghaus@dentaldirekt.de

Bestellhotline:

05225.863 19-0

Per E-Mail an:

info@dentaldirekt.de

Jetzt 24/7 online bestellen!

www.dentaldirekt.de/de/produkte/dd-solid-connect

Bedingungen: Das Design von gelieferten Geräten, Material oder Zubehör kann geringfügig von den Abbildungen abweichen.
Es gelten die AGB der Dental Direkt GmbH, Spenge. Mit ® gekennzeichnete Namen sind Waren- und/oder Markenzeichen der Hersteller.

Die gültigen AGB der Dental Direkt GmbH finden Sie hier: www.dentaldirekt.de/de/agb



Dental Direkt GmbH

Industriezentrum 106 – 108 | 32139 Spenge | Germany

Tel: +49 5225 86319-0 | E-Mail: info@dentaldirekt.de | www.dentaldirekt.de

Die mit ® gekennzeichneten Namen sind eingetragene Marken der Hersteller und/oder urheberrechtlich geschützt. Für fehlerhafte Angaben in dieser Preisliste und deren Folgen übernehmen wir keine Haftung. Es gelten unsere allgemeinen Verkaufs- und Lieferbedingungen. Die Preise verstehen sich in Euro netto zzgl. gesetzlicher MwSt. Technische Änderungen, Preisänderungen und Liefermöglichkeit sind vorbehalten.

